

TerraCast[®]

PRODUCTS

TerraCast[®] Products, LLC
 4400 NW 19th Avenue, Unit K
 Pompano Beach, FL 33064
 Office: 305-895-9525 x105
 Fax: 305-895-7879

| REVISIONS | | | | |
|-----------|-------------|------|-------|----------|
| REV | DESCRIPTION | ECN | DATE | APPROVED |
| XI | PRELIMINARY | ---- | ----- | |

SPECS AT A GLANCE

Top ID: 33''
 Top OD: 46''
 BASE ID: 35''
 HEIGHT: 30''
 VOLUME: 111 GALLONS
 14.8FT³

WEIGHT: 57LBS

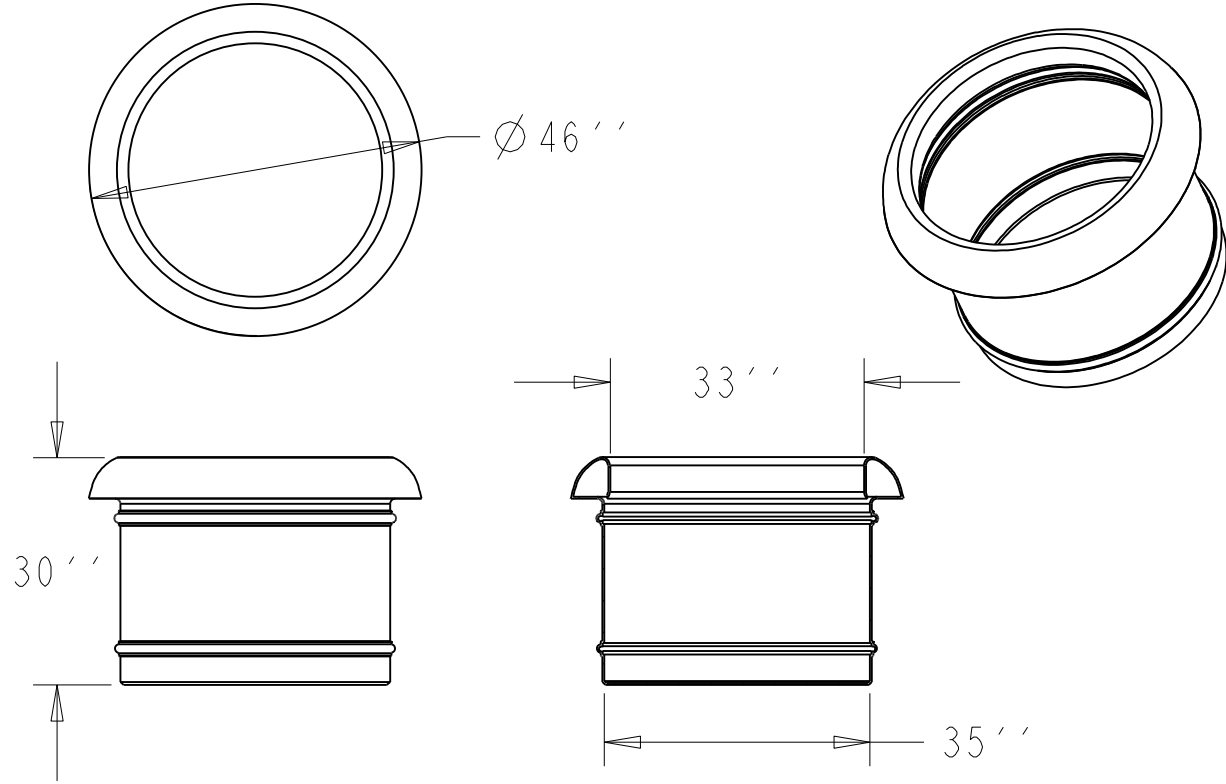

| | | | | |
|---------------------------------|-----------|--|---------------------------|--------|
| DIMENSION UNITS | | TerraCast[®] PRODUCTS | | |
| INCHES | MATERIAL: | SCALE | DRAWN BY | |
| TOLERANCES (EXCEPT AS NOTED) | | 0.040 | www.Terracastproducts.com | |
| XX = ±0.01 | TITLE | | | I OF I |
| XXX = ±0.001 | TCB-8 | | | |
| ANGULAR | DATE | PART #: | TCB-8 | REV |
| ±0.5 | May-11-15 | (A SIZE) | | XI |

This document contains TERRACAST PROPRIETARY INFORMATION. No intellectual property right or license is granted by TERRACAST in connection with it. It is delivered on the express condition that the document and the information contained in it shall be treated as confidential, shall not be used for and purpose other than that for which it is hereby delivered (the use and maintenance of the product supplied). It shall not be disclosed in whole or part to third parties and shall not be duplicated in any manner without TERRACAST's prior written consent.