

TerraCast[®]

PRODUCTS

TerraCast[®] Products, LLC
 4400 NW 19th Avenue, Unit K
 Pompano Beach, FL 33064
 Office: 305-895-9525 x105
 Fax: 305-895-7879

REVISIONS				
REV	DESCRIPTION	ECN	DATE	APPROVED
XI	PRELIMINARY	---	---	---

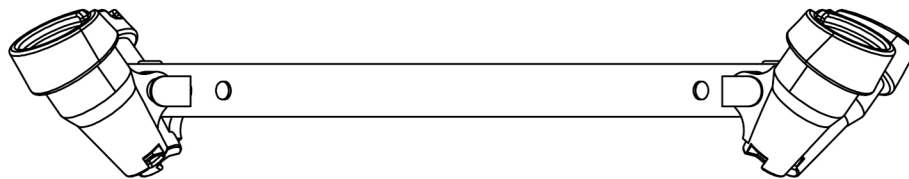
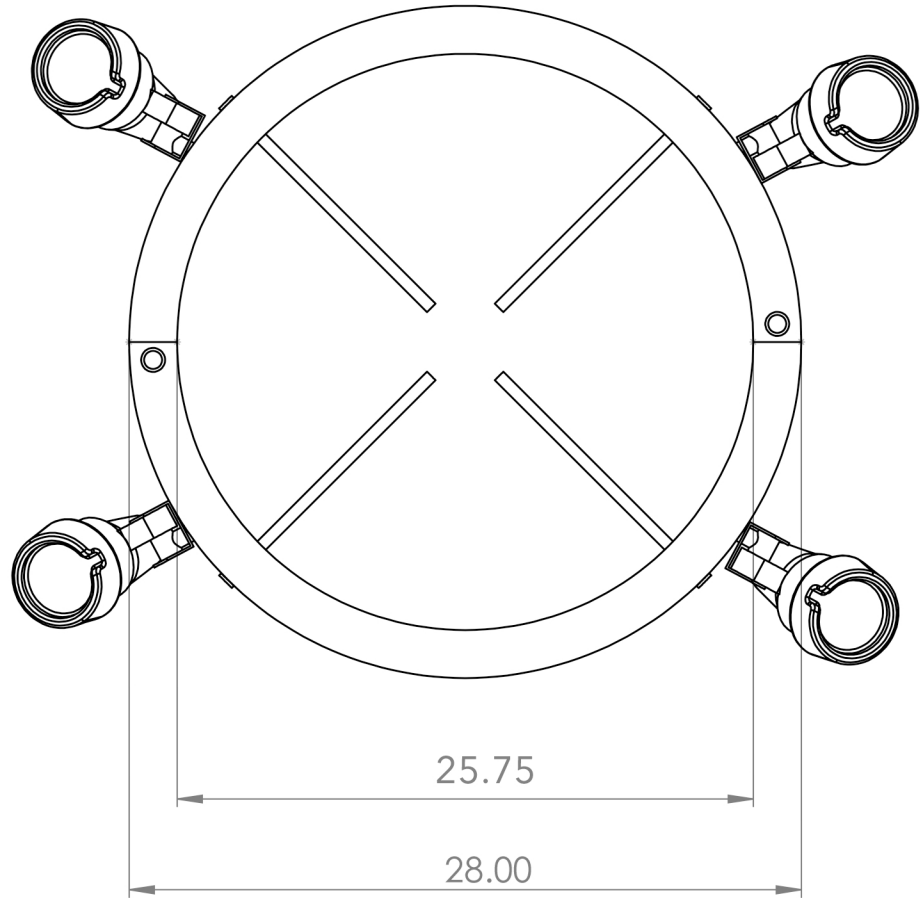
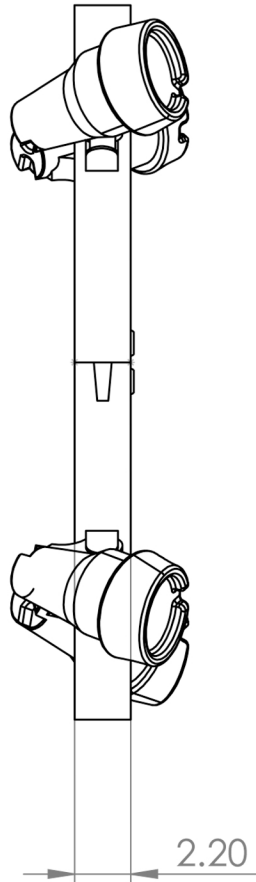

DIMENSION UNITS	TerraCast[®] PRODUCTS		
TOLERANCES (EXCEPT AS NOTED)	MATERIAL:	SCALE 0.023	DRAWN BY
XX = ±0.01	TITLE 24 inch Tree Ring		I OF I
XXX = ±0.001			
ANGULAR ±0.5	DATE	PART #: (A SIZE)	REV XI

This document contains TERRACAST PROPRIETARY INFORMATION. No intellectual property right or license is granted by TERRACAST in connection with it. It is delivered on the express condition that the document and the information contained in it shall be treated as confidential, shall not be used for and purpose other than that for which it is hereby delivered (the use and maintenance of the product supplied). It shall not be disclosed in whole or part to third parties and shall not be duplicated in any manner without TERRACAST's prior written consent.