

TerraCast[®]

PRODUCTS

LIGHTING CATALOG

INNOVATIVE.
ENDURING.
STRONG.



Innovation With **Resin Based** Commercial Outdoor Products

WWW.TERRACASTPRODUCTS.COM

TerraCast®

The TerraCast® lighting line offers unique reproductions of early American decorative light posts and luminaires. Our signature styles, the Washington and New England designs, will create an eloquent atmosphere to any entrance, courtyard or walkway. For the past 40 years TerraCast® Products contributions have been a key ingredient in making projects an elegant success.

POLYSTEEL™ POST

The POLYSTEEL™ POST utilizes the latest in composite technology to provide a beautiful and affordable decorative post which looks like cast iron. Our posts are made by combining three components giving them the structural benefits of steel with the low maintenance of polymer resins.

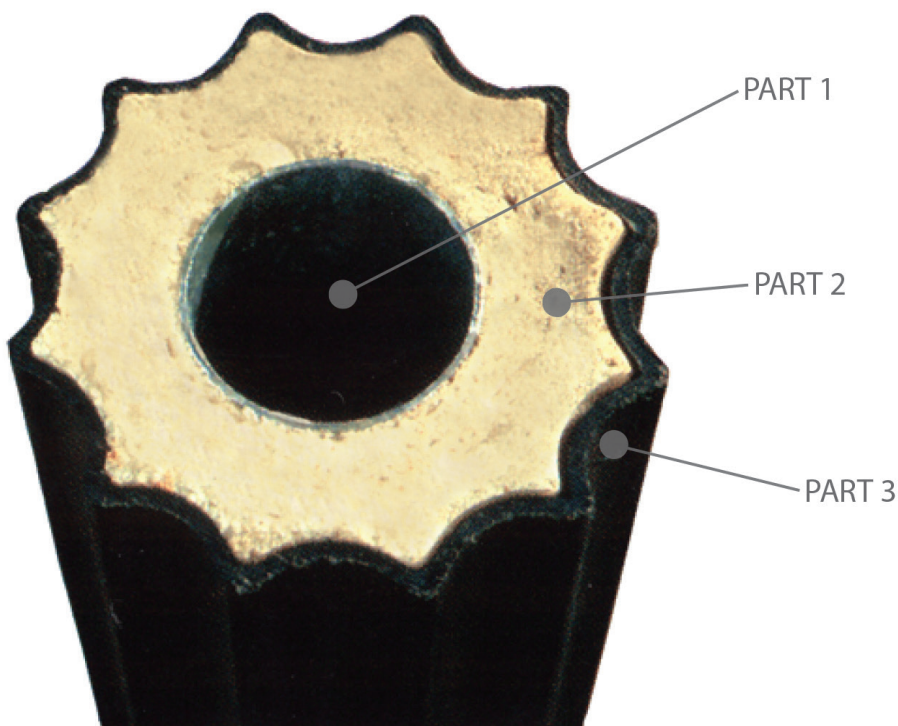

PART 1 GALVANIZED STEEL PIPE

Provides a rigid structure and allowing for the ease of wiring.

PART 2 CLOSED CELL FOAM

The closed cell-polyurethane foam provides a solid encasement fusing the galvanized pole with the polyethylene exterior.

PART 3 LINEAR LOW DENSITY POLYETHYLENE

The rich black color of the LDPE is the same reliable and proven material used to coat outdoor telephone cable.

- 
- 5 Materials
 - 6 Washington Style Light Poles
 - 11 Madison Style Light Poles
 - 12 New England Style Light Poles
 - 16 Luminaires
 - 18 Globes and Street Lamps
 - 19 Accessories
 - 20 Decorative Bases
 - 22 Bollards
 - 22 Case Study



TERRACAST® BASES ARE MADE WITH UV STABILIZED LINEAR LOW DENSITY POLYETHYLENE (LLDPE) RESIN MATERIAL. OUR LLDPE RESIN IS SPECIALLY FORMULATED, DESIGNED AND MANUFACTURED TO WITHSTAND YEARS IN THE SUN AND HARSH CLIMATES. THE UV STABILIZED, COLOR THROUGH MATERIAL PROVIDES A LIFETIME OF VIBRANT COLORS. WE HAVE DEVELOPED A RECYCLED BLACK COLOR THAT IS MADE PRIMARILY FROM POST-CONSUMER RECYCLED MATERIAL TO FURTHER OUR COMMITMENT TO REDUCE WASTE. OUR RESIN PRODUCTS ARE 100% RECYCLABLE AND SHOULD NEVER END UP IN THE LANDFILL.

MATERIAL BENEFITS

PolySteel™ Post Benefits

- Low Initial Cost
- Lower Installation Cost
- Rust Resistant
- Corrosion Resistant
- Crack Resistant
- Lightweight
- No Maintenance Required
- Color Through Material
- Chip Resistant
- Never Needs Painting
- Resists Salt
- Resists Pet Markings/Stains
- Defends Against Extreme Weather and Temperatures
- Electrical Insulator
- Anti-Magnetic

FEATURES OF OTHER LIGHT POLE MATERIALS

FIBERGLASS POLES

- UV Damage
- Easily Damaged
- Fading
- Blossoming
- Delaminating
- Chalking
- Maintenance Required
- No Recycle Value
- Airborne Fibers
- Electrical Insulator
- Anti-Magnetic

ALUMINUM POLES

- Long Turnaround
- Paint Chipping
- Corroding
- Higher Costs

STEEL POLES

- Corroding
- Rusting
- Heavy
- Larger Equipment Required
- Higher Maintenance

CONCRETE POLES

- Corroding
- Cracking
- Heavy
- No Breakaway Performance
- More Hazardous
- Larger Equipment Required
- No Recycle Value
- Emit Greenhouse Gases in Production

MATERIAL	LOW COST	LOW INSTALL COST	RUST RESISTANT	CORROSION RESISTANT	CRACK RESISTANT	LIGHT-WEIGHT	NO MAINTENANCE	COLOR THRU MATERIAL	CHIP RESISTANT	NO PAINTING NEEDED	SALT RESISTANT	WEATHER RESISTANT	RECYCLE VALUE
POLYSTEEL™	✓	✓	✓	✓	✓	✓	✓	✓	✓	✓	✓	✓	✓
FIBERGLASS	✓	✓	✓	✓		✓			✓		✓		
ALUMINUM						✓							✓
STEEL	✓	✓											
CONCRETE								✓					



PolySteel™ Pole



Fiberglass Pole Blossoming



Concrete Pole Cracking



Metal Pole Rusting



Metal Pole Corroding

WASHINGTON STYLE



TerraCast® Products has been helping municipalities, builders, and lighting contractors solve maintenance challenges since 1984 through our Classic Lamp Posts division. The challenge of maintaining the classic design of architectural decorative light posts while eliminating the rusting, peeling paint and fading is solved by TerraCast® Products proprietary PolySteel™ construction. The Washington Post replicates the classic bell shape base and decorative fluted stem. The UV stabilized material provides a solution that will never need to be painted to maintain its deep black 19th-century look. The material is color through, which means there's no paint to chip. In combination with LED-powered light fixtures and the classic design, the PolySteel™ posts will provide extended years of maintenance-free satisfaction.



FOOTING DETAILS

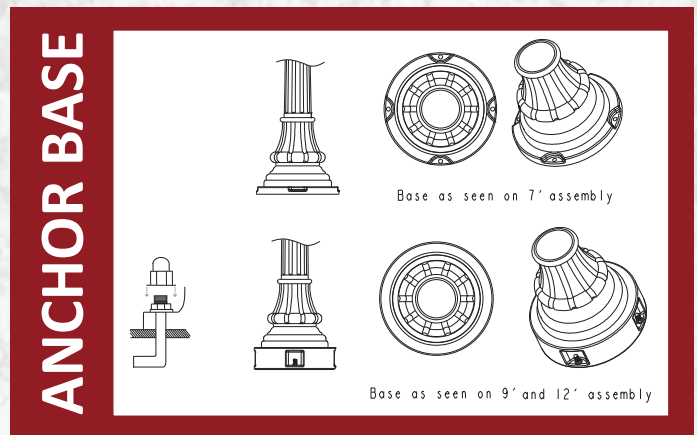
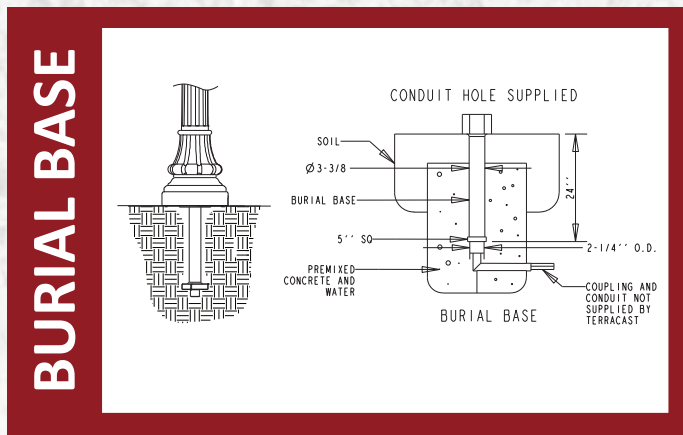

ITEM #	COLOR	FOOTING	POLE HEIGHT	BURIAL DEPTH	BASE DIAMETER
CL70031	BLACK	BURIAL BASE	6' 6"	18"	15"
CL70131	BLACK	BURIAL BASE	8' 10"	23"	15"
CL80152	BLACK	ANCHOR BASE	6' 4"	—	15"
CL80151	BLACK	ANCHOR BASE	8' 10"	—	15"

WASHINGTON STYLE

*Available both in anchor base and burial base.

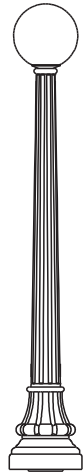

W1

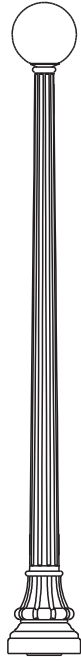

W2

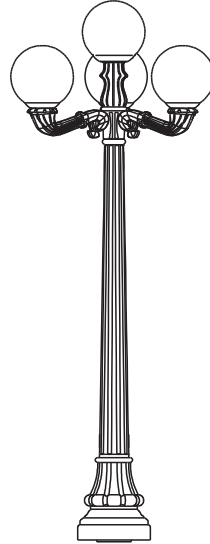

W3

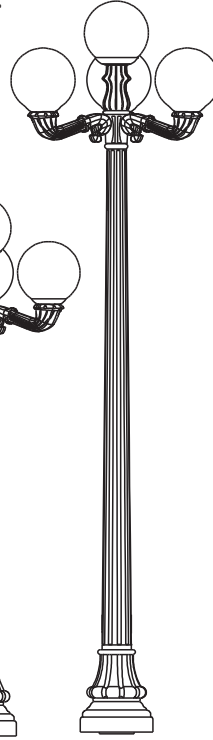

W4

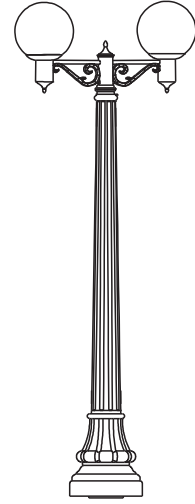

W5

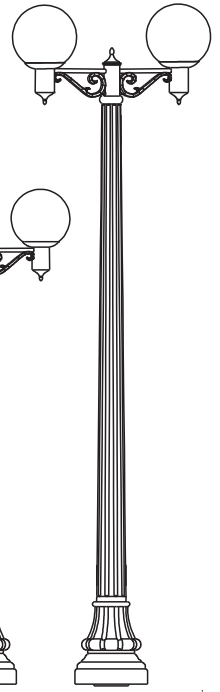

W6

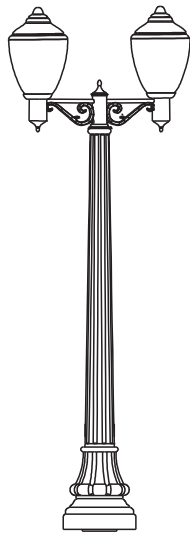

W11

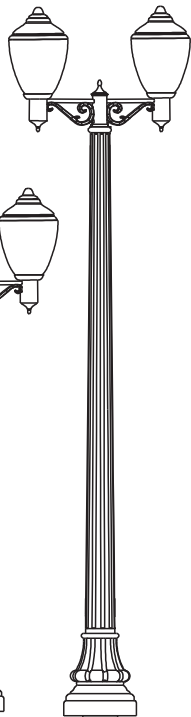

W12

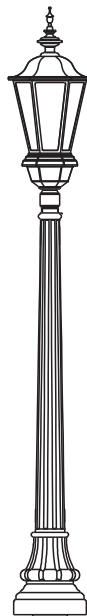

W17

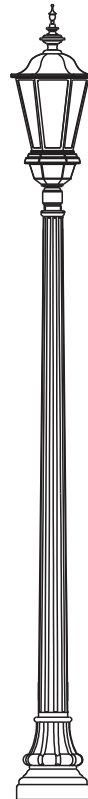

W18

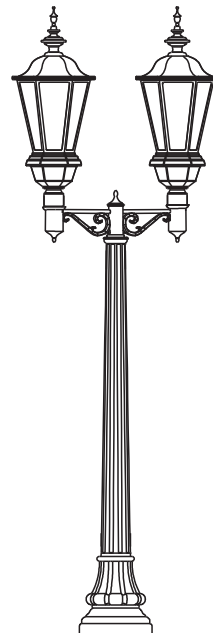

W19

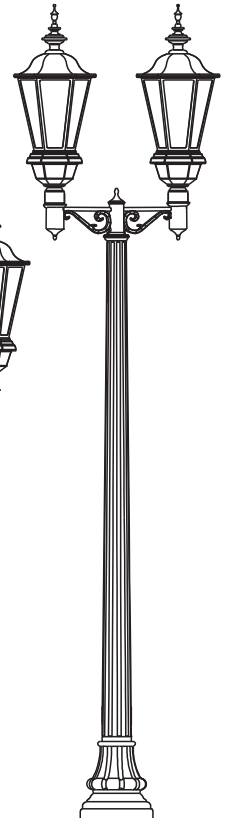

W20

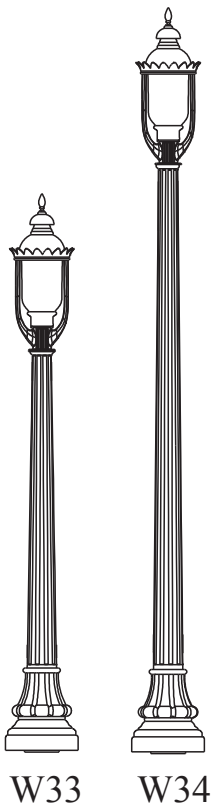
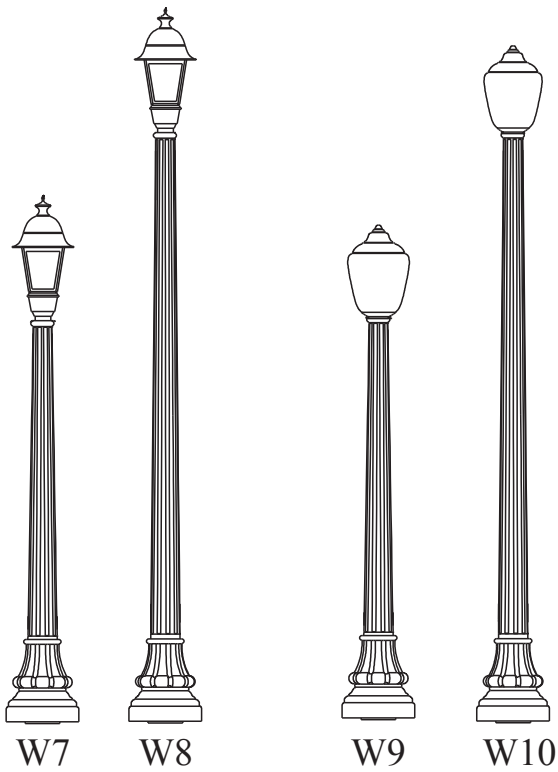

W1
7' WASHINGTON
12" GLOBE
POST TOP FITTER

W11
7' WASHINGTON
17" ACORN
SCROLL ARM

W2
9' WASHINGTON
12" GLOBE
POST TOP FITTER

W12
9' WASHINGTON
17" ACORN
SCROLL ARM

W3
7' WASHINGTON
12" GLOBE
VICTORIAN ARM - V4

W17
7' WASHINGTON
LE BRITON

W4
9' WASHINGTON
12" GLOBE
VICTORIAN ARM - V4

W18
9' WASHINGTON
LE BRITON

W5
7' WASHINGTON
12" GLOBE
SCROLL ARM

W19
7' WASHINGTON
LE BRITON
SCROLL ARM

W6
9' WASHINGTON
12" GLOBE
SCROLL ARM

W20
9' WASHINGTON
LE BRITON
SCROLL ARM

W7
7' WASHINGTON
WOODSIDE HILLS

W33
7' WASHINGTON
CARRIAGE HOUSE

W8
9' WASHINGTON
WOODSIDE HILLS

W34
9' WASHINGTON
CARRIAGE HOUSE

W9
7' WASHINGTON
17" ACORN
POST TOP FITTER

W10
9' WASHINGTON
17" ACORN
POST TOP FITTER

TALLER OPTIONS



The **PolyComposite™** post is made with a fiberglass pole core instead of a steel pole. This allows for taller posts without sacrificing strength. The PolyComposite™ posts are available in 12' and 16' heights. Our taller options are available in Washington and Madison style. The 12' pole is available in both anchor and burial base, while the 16' is only available in a burial base style.

PART ONE: FIBERGLASS POLE

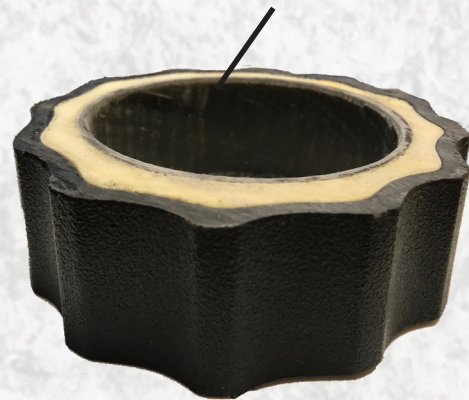

ITEM #	COLOR	FOOTING	POLE HEIGHT	BURIAL DEPTH	BASE DIAMETER
CL70210*	BLACK	BURIAL BASE	12'	36"	20"
CL70211	BLACK	BURIAL BASE	12'	36"	20"
CL70213	BLACK	BURIAL BASE	16'	48"	20"
CL80161	BLACK	ANCHOR BASE	12'	—	20"

*Indicates PolySteel™

MADISON STYLE



The Madison style features the same qualities as our New England and Washington styles. It's century-old look provides projects with a unique historic feel. TerraCast®'s modern interpretation of the Madison style will accent any installation with beautiful, maintenance-free poles and bases.

The Madison style is available in a **PolyComposite™** burial base configuration. The Madison bases are interchangeable in two sizes; 31" and 36" tall.

ITEM #	COLOR	FOOTING	POLE HEIGHT	BURIAL DEPTH	BASE DIAMETER	BASE HEIGHT
CL1700	BLACK	BURIAL BASE	17' 1"	48"	17"	31"
CL1800	BLACK	BURIAL BASE	17' 6"	48"	19"	36"

NEW ENGLAND STYLE



Are you tired of having the plaguing problem of corroding, pitting, rotting or cracking light pole bases?

The New England style lamp post is a builders dream.

Why? Whether you're constructing a multi-story multifamily complex, retail center, or building a subdivision, allowing TerraCast®'s New England poles to light the way for you means that your light poles are guaranteed a long-lasting maintenance-free life. Utilizing the latest in composite technology, TerraCast® continues to produce the PolySteel™ pole which has been serving neighborhoods, strip centers and apartment complexes for nearly forty years. Installing New England style poles can capture and preserve a historic look while smoothly transitioning the ambiance of any cityscape into a development. The monolithic, or single piece, pole and base design do not allow for weak points in the construction of the pole and base. Typical aluminum and steel poles have bases that have been welded to the structural pole, creating a possible weak point, or an opportunity for corrosion among dissimilar metals.



FOOTING DETAILS

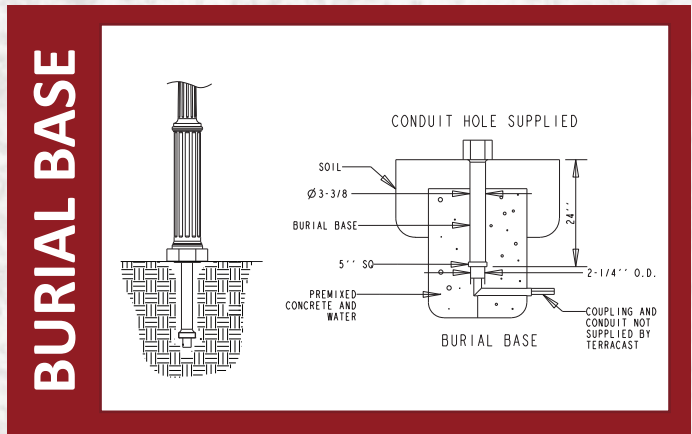

ITEM #	COLOR	FOOTING	POLE HEIGHT	BURIAL DEPTH	BASE DIAMETER
CL70011	BLACK	BURIAL BASE	6' 6"	18"	10"
CL70111	BLACK	BURIAL BASE	8' 10"	23"	10"

NEW ENGLAND STYLE

*Only available in burial base.

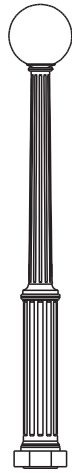

N1



N2

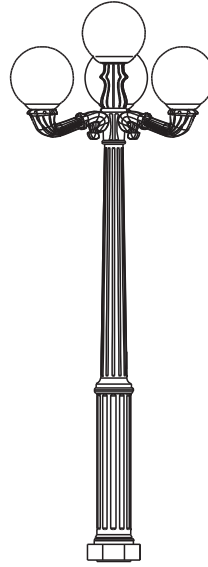

N3

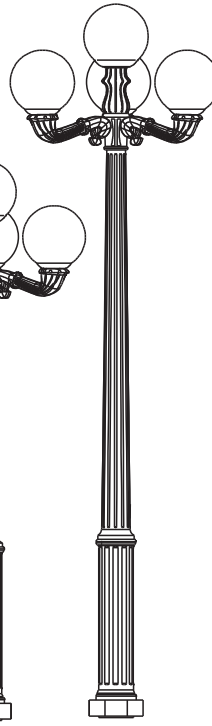

N4

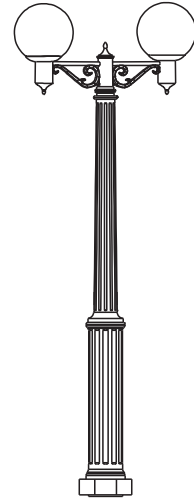

N5

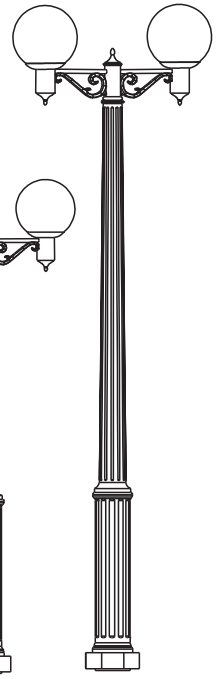

N6

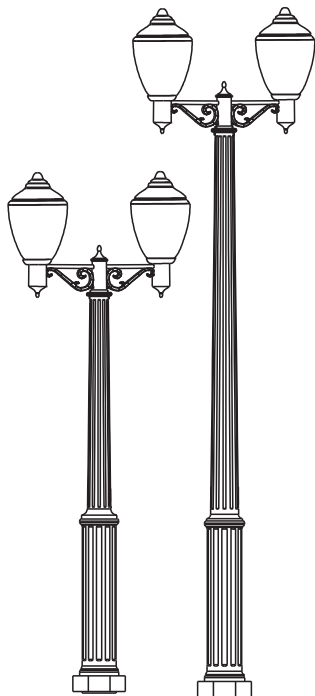

N11

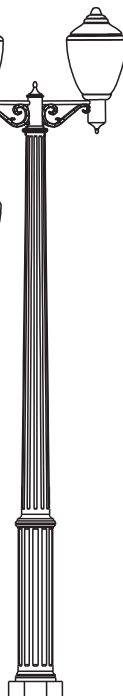

N12



N17

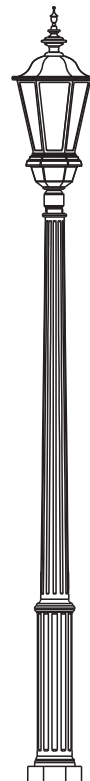

N18

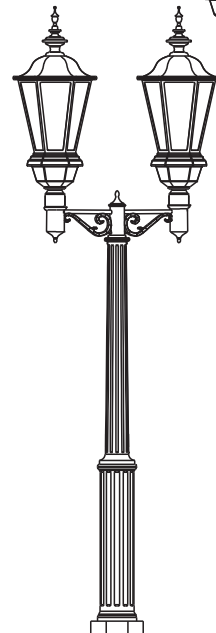

N19

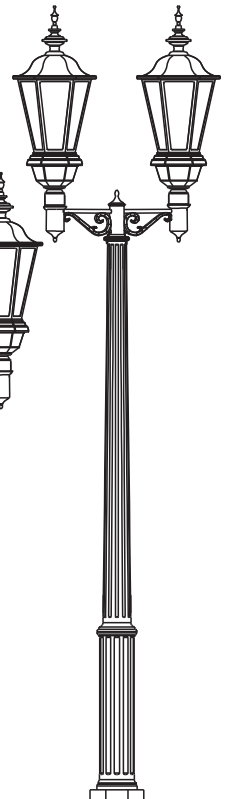

N20

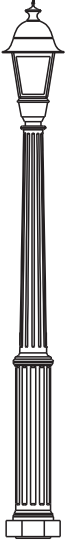

N7

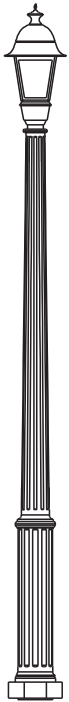

N8



N9



N10



N33



N34

N1
7' NEW ENGLAND
12" GLOBE
POST TOP FITTER

N2
9' NEW ENGLAND
12" GLOBE
POST TOP FITTER

N3
7' NEW ENGLAND
12" GLOBE
VICTORIAN ARM - V4

N4
9' NEW ENGLAND
12" GLOBE
VICTORIAN ARM - V4

N5
7' NEW ENGLAND
12" GLOBE
SCROLL ARM

N6
9' NEW ENGLAND
12" GLOBE
SCROLL ARM

N7
7' NEW ENGLAND
WOODSIDE HILLS

N8
9' NEW ENGLAND
WOODSIDE HILLS

N9
7' NEW ENGLAND
17" ACORN
POST TOP FITTER

N10
9' NEW ENGLAND
17" ACORN
POST TOP FITTER

N11
7' NEW ENGLAND
17" ACORN
SCROLL ARM

N12
9' NEW ENGLAND
17" ACORN
SCROLL ARM

N17
7' NEW ENGLAND
LE BRITON

N18
9' NEW ENGLAND
LE BRITON

N19
7' NEW ENGLAND
LE BRITON
SCROLL ARM

N20
9' NEW ENGLAND
LE BRITON
SCROLL ARM

N33
7' NEW ENGLAND
CARRIAGE HOUSE

N34
9' NEW ENGLAND
CARRIAGE HOUSE

LUMINAIRES



FAIRVIEW



LE BRITON



WILLIAMSBERG

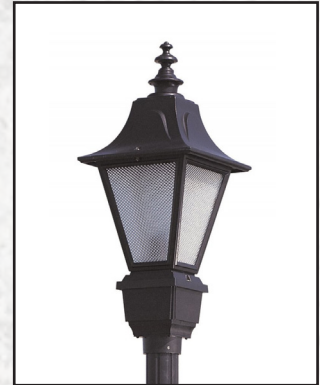

WOODSIDE HILLS



FILLMORE



CARRIAGE HOUSE



NEPTUNE



ATHENA

NAME	ITEM #	COLOR	PANEL & GLOBE OPTIONS	LIGHT SOURCE	LED LIGHT SOURCE	HEIGHT	WIDTH	ID
ATHENA	TC41T	BLACK	CLEAR GLASS LENS	—	85W/6100LM	26.5"	25.63"	3"
CARRIAGE HOUSE	CH35	BLACK	MILK ACRYLIC LENS	MEDIUM BASE	—	35"	16.5"	3"
CARRIAGE HOUSE LTE	TC124	BLACK	CLEAR LENS	75W MAX MEDIUM BASE INCANDESCENT	15W/1400LM 10W/800LM	22.5"	12.5"	3"
FAIRVIEW	TC36T	BLACK	OPAL ACRYLIC	200W MAX MEDIUM BASE INCANDESCENT	60W/6000LM 54W/7200LM	33"	12.5"	3"
FILLMORE	TCD142-FS22	BLACK	TYPE 5 SEGMENTED REFLECTOR CLEAR GLASS LENS	250MH-PS 250HPS	—	17"	22"	4"
LE BRITON	TC33T	BLACK	OPAL ACRYLIC	200W MAX MEDIUM BASE INCANDESCENT	60W/6000LM 54W/7200LM	35.75"	14"	3"
NEPTUNE	TC40T	BLACK	FROST FLAT LENS	—	60W/6000LM	27"	20.5"	3"
WILLIAMSBERG	TCH1490B4ST	BLACK	ACRYLIC LENS	250HPS 250MH	57W	33.5"	16"	3"
WOODSIDE HILLS	TC31T	BLACK	OPAL ACRYLIC	200W MAX MEDIUM BASE INCANDESCENT	60W/6000LM 54W/7200LM	26.75"	11.5"	3"

Our line of traditional to contemporary luminaires includes several shapes and styles, from the simple, classic globe (seen often on docks and near pools), to the traditional decorative post top seen lining Main Streets, USA.



VICTORIAN



ALBERT R3



ALBERT R5



RICHMOND



TOWNSEND



NEW CASTLE



ROCHESTER



GLENDALE

NAME	ITEM #	COLOR	PANEL & GLOBE OPTIONS	LIGHT SOURCE	LED LIGHT SOURCE	HEIGHT	WIDTH	ID
ALBERT R3	TCHTM25-RV	BLACK	POLYCARBONATE	250HPS 250MH	35W	36"	16"	3"
ALBERT R5	TCHTM25-R3	BLACK	POLYCARBONATE	250HPS 250MH	35W	36"	16"	3"
GLENDALE	TC2014T	BLACK	OPAL POLYCARBONATE	200W MAX MEDIUM BASE INCANDESCENT	60W/6000LM 54W/7200LM	27"	18"	3"
NEW CASTLE	TC94T	BLACK	CLEAR TEXTURED POLYCARBONATE	200W MAX MEDIUM BASE INCANDESCENT	60W/6000LM 54W/7200LM	40.5"	16.75"	3"
RICHMOND	TC78T	BLACK	CLEAR TEXTURED POLYCARBONATE OPAL TEXTURED ACRYLIC	200W MAX MEDIUM BASE INCANDESCENT	60W/6000LM 54W/7200LM	29.5"	15.5"	3"
ROCHESTER	TCHTM4392	BLACK	ARCYLIC LENS	250HPS 250MH	57W	40"	19"	3"
TOWNSEND	TC92T	BLACK	CLEAR TEXTURED POLYCARBONATE	200W MAX MEDIUM BASE INCANDESCENT	60W/6000LM 54W/7200LM	40.5"	16.75"	3"
VICTORIAN	TC83T	BLACK	CLEAR TEXTURED POLYCARBONATE OPAL TEXTURED ACRYLIC	200W MAX MEDIUM BASE INCANDESCENT	60W/6000LM 54W/7200LM	30"	14.25"	3"
VICTORIAN	TC86T	BLACK	CLEAR TEXTURED POLYCARBONATE OPAL TEXTURED ACRYLIC	200W MAX MEDIUM BASE INCANDESCENT	60W/6000LM 54W/7200LM	35.75"	16.75"	3"

GLOBES AND STREET LAMPS

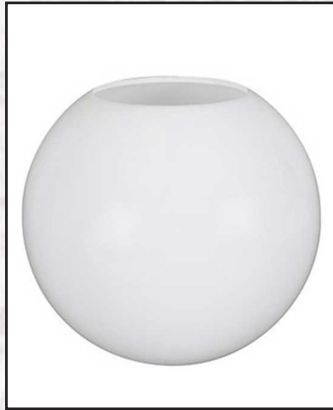

SPHERE



VICTORIAN



ACORN



ALEX

From a standard round shape to a classic Acorn or Victorian shape, TerraCast®'s line of globes is offered in materials resistant to UV, weathering and aging for low maintenance and shatter-free replacement options. Our durable and impact resistant materials make our replacement globes last longer and are more reliable. Depending on the style, globes are available in polycarbonate, acrylic, or polyethylene in various sizes, colors and textures to fit many applications.

NAME	SIZE/HT	WIDTH	ID	OD	MATERIAL	COLOR
ACORN	17"	12"	5.25"	6"	POLYETHYLENE	WHITE
	17"	12"	5.25"	6"	ACRYLIC POLYCARBONATE	CLEAR
	23"	15"	7.12"	8"	ACRYLIC POLYCARBONATE	CLEAR WHITE
ALEX	27.19"	15.90"	7.27"	8.14"	ACRYLIC	CLEAR
	27.02"	15.90"	7.75"	9.13"	ACRYLIC	CLEAR
SPHERE	12"	12"	5.25"	—	ACRYLIC POLYCARBONATE	CLEAR WHITE
	14"	14"	5.25"	—	ACRYLIC POLYCARBONATE	CLEAR WHITE
	16"	16"	5.25"	—	ACRYLIC POLYCARBONATE	CLEAR WHITE
	18"	18"	5.25"	—	ACRYLIC POLYCARBONATE	CLEAR WHITE
	20"	20"	5.25"	—	ACRYLIC POLYCARBONATE	CLEAR WHITE
VICTORIAN	17"	11"	5.25"	5.88"	POLYETHYLENE	WHITE
	17"	11"	5.25"	5.88"	ACRYLIC POLYCARBONATE	CLEAR
	21"	14"	7.12"	8"	ACRYLIC POLYCARBONATE	CLEAR
	27"	17"	7.12"	8"	ACRYLIC POLYCARBONATE	CLEAR

ACCESSORIES



POST TOP FITTER

UV stabilized, polycarbonate fitter. Secures neckless globe with an opening of 5.25" and a 3" post tenon.



8" GLOBE FITTER

Decorative aluminum fitter accommodates globes that have an 8" extended neck. Height: 10.5" Length: 10.25"



VICTORIAN 5 ARM V5

LLDPE resin decorative arm. Fits neckless globes with 5.25" opening. Height: 23" Length: 31"



DECORATIVE SCROLL ARM

Powder coated aluminum scroll arm in black. Fits post top with 3" diameter. Height: 13" Length: 30"



CLASSIC CROSS ARM

Cast aluminum with black powder coat. Fits post top with 3" diameter. Height: 9.5" Length: 29"



VICTORIAN 4 ARM V4

LLDPE resin decorative arm. Fits neckless globes with 5.25" opening. Height: 16" Length: 25"



BALL FINIAL ALUMINUM



ACORN FINIAL ALUMINUM



PINEAPPLE FINIAL ALUMINUM



ACORN FINIAL RESIN

DECORATIVE LIGHT POLE BASES



Our resin light pole bases affix easily to your existing light poles, protecting the most vulnerable spots. The bottom of a pole is more prone to damages, where moisture seeps in, creating a starting point for corrosion. Though not designed to reverse the effects of corrosion, our bases are excellent at eliminating additional entry points and greatly enhance curb appeal. They improve safety and reduce the risk of theft because they have no scrap value, unlike metal parts.

**ARGENTA****BERKLEY****BERMUDA****BOARDWALK****DALLAS****DELAWARE****GILLETTE****GOLDEN BEACH****MADISON****MAPLE LEAF****NOLA****PINNACLE****SARASOTA****TAMPA****WASHINGTON**

NAME	ITEM #	STYLE	BASE OD	POLE DIA	HT
ARGENTA	TC-ARG52	CLAM SHELL	30"	UP TO 18"	52"
BERKLEY	TC-BRK42	CLAM SHELL	20.74"	7.74"	42"
BERMUDA	TC-BER24	CLAM SHELL	12"	3" / 4"	24"
BOARDWALK	TC-BOR18	CLAM SHELL	32"	10.5"	18"
DALLAS	TC-DAL39	CLAM SHELL	36"	UP TO 18"	39"
DELAWARE	TC-DEL28	CLAM SHELL	26.5"	UP TO 10"	27.75"
GILLETTE	TC-GIL34	CLAM SHELL	24"	6" / 7.75"	34"
GOLDEN BEACH	TC-GOL22	DROP OVER	12"	3" / 4"	22"
MADISON	TC-MAD31	DROP OVER	17"	UP TO 8"	30.5"
	TC-MAD36	DROP OVER	19"	UP TO 10"	36"
	TC-MAD31-6.5	CLAM SHELL	19.25"	6.5"	31.25"
MAPLE LEAF	TC-MAP40	CLAM SHELL	21"	UP TO 7"	40"
	TC-MAP45	CLAM SHELL	30"	UP TO 10.5"	44.5"
NOLA	TC-NOL12	CLAM SHELL	28"	UP TO 20.5"	12"
PINNACLE	TC-PIN25	CLAM SHELL	25"	UP TO 13"	25"
SARASOTA	TC-SAR20	CLAM SHELL	16"	UP TO 11"	20"
TAMPA	TC-TAM51	CLAM SHELL	46"	UP TO 22"	51"
WASHINGTON	TC-WAS18	DROP OVER	19"	UP TO 5"	18"

BOLLARDS



PolySteel™ Bollard BOLLARD MOUNT TYPE

BURIAL BASE
ANCHOR BASE

NAME	ITEM #	MATERIAL	HEIGHT	WIDTH	LED	VOLTAGE
BURIAL BASE	TCP-CL70301	POLYSTEEL	42.5"	9.5"	15W	120V
ANCHOR BASE	TCP-CL80309	POLYSTEEL	45"	9.5"	15W	120V



Round Vented Bollard MOUNT TYPE

BURIAL BASE

NAME	ITEM #	MATERIAL	HEIGHT	WIDTH
ROUND VENTED BOLLARD	TCP6002710	POLYETHYLENE	33.5"	10"

CASE STUDY

Ship Bottom, New Jersey

The Borough of Ship Bottom, New Jersey had redeveloped a few public areas and plazas with TerraCast® PolySteel™ posts in our standard Tennessee Green. The light poles weathered several winters and storms, but after superstorm Sandy, we called our friends in Ship Bottom to find out if everyone was okay.

They commented that they were ready to buy and install some more light poles. It wasn't because their TerraCast® poles had been damaged, it was because all the other Non-PolySteel™ poles had been destroyed! Now, a large selection of the light poles in Ship Bottom are PolySteel™.



SUSTAINABLE BRAND

At TerraCast®, we deeply care about our planet and we are committed to environmentally friendly practices every step of the way from start to finish. We are proud to say that our products can be manufactured using up to 100% recycled content and our manufacturing process is virtually waste free. Our products are 100% recyclable and should never end up in a landfill.

FREIGHT POLICY

All shipments are F.O.B. factory and freight collect.

Please see our complete freight policy online at:

<https://www.terracastproducts.com/shipping-return-policy/>

LIMITED WARRANTY

TerraCast® Products warrants its products to be free from defects and workmanship. Please read our complete limited warranty online at:

<https://www.terracastproducts.com/warranties/>

TerraCast® Products is not responsible for typographical errors. Measurements in this catalog are rounded to the nearest quarter inch and may not be exact due to manufacturing variances. TerraCast® Products reserves the right to alter and change specifications. Please check our latest catalog online and call customer service to confirm critical measurements.

INNOVATIVE. ENDURING. STRONG.

TerraCast[®]

PRODUCTS

o: 305.895.9525

f: 305.895.7879

info@terracastproducts.com

4400 NW 19th Avenue, Unit K
Pompano Beach, FL 33064