

TerraCast[®]

PRODUCTS

TERRACAST PRODUCTS LLC
 4400 NW 19TH AVENUE, UNIT K
 POMPANO BEACH, FL 33064
 305-895-9525
 INFO@TERRACASTPRODUCTS.COM

SPECS AT A GLANCE

LENGTH: 96"
 HEIGHT: 16-1/4"
 WEIGHT: 64 LBS

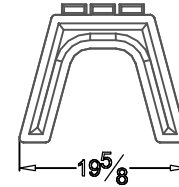
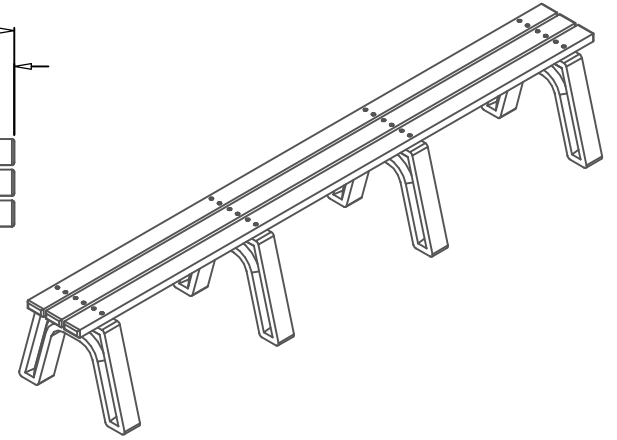
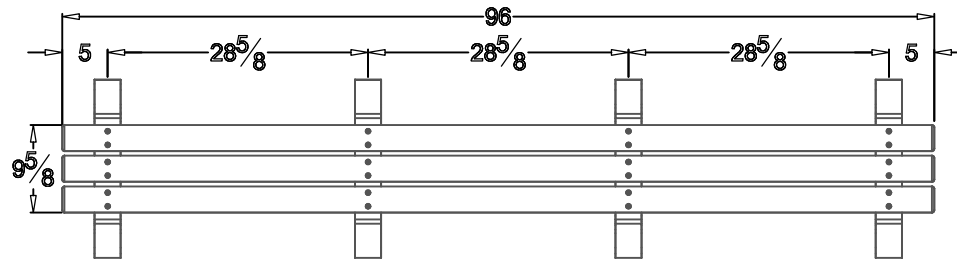

DO NOT SCALE DRAWINGS.
 All measurements are rounded to the closest quarter inch and may not be exact due to manufacturing variances.
 This document contains TERRACAST[®] PROPRIETARY INFORMATION. No intellectual property right or license is granted by TERRACAST[®] in connection with it. It is delivered on the express condition that the document and the information contained in it shall be treated as confidential, shall not be used for and purpose other than that for which it is hereby delivered (the use and maintenance of the product supplied). It shall not be disclosed in whole or part to third parties and shall not be duplicated in any manner without TERRACAST[®]'s prior written consent.

| | | | | |
|--|---------------------------|--------|------------------|-----------|
| TerraCast[®] PRODUCTS | | | | |
| TITLE Economizer Flat Bench | | | | |
| PART# EM8F | | | DRAWN KT | |
| SIZE | MATERIAL Recycled HDPE | DWG NO | DATE 11-10-21 | REV |
| SCALE | | WEIGHT | | SHEET 1/1 |